

Sicherungsdetails

LHD Batterie-Verteiler-Box (BJB)

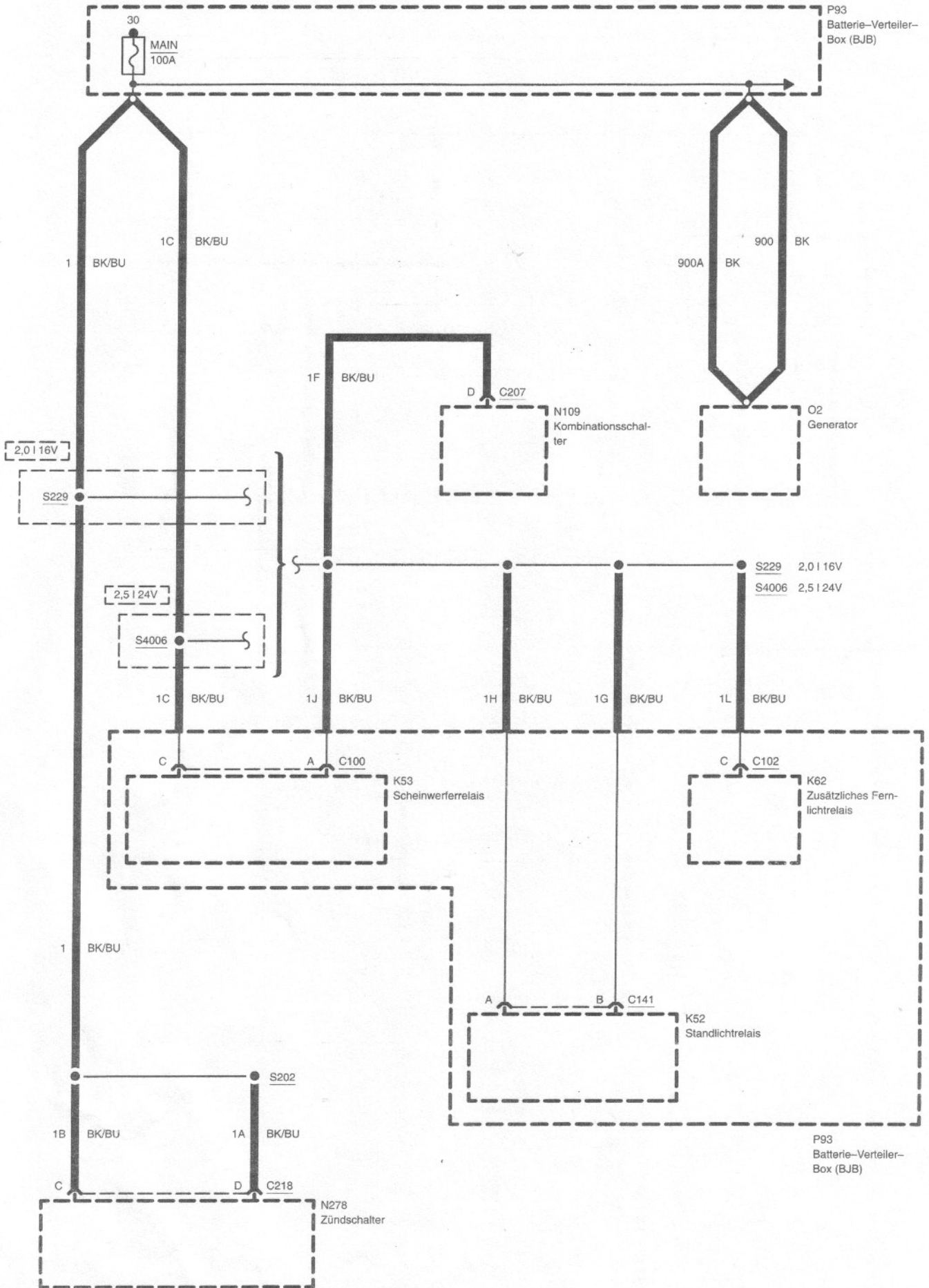

Batterie-Verteiler-Box (BJB)

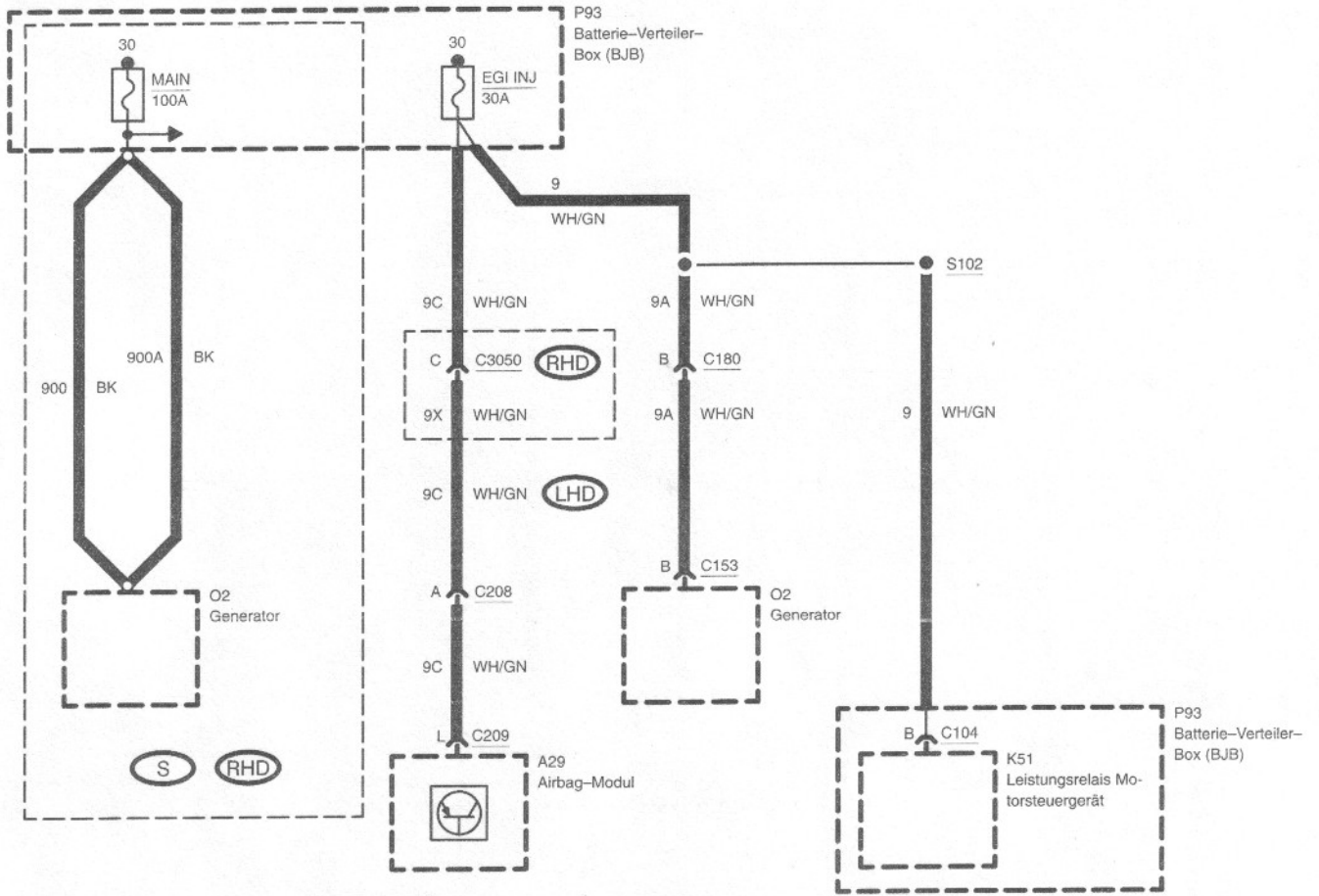

Batterie-Verteiler-Box (BJB)

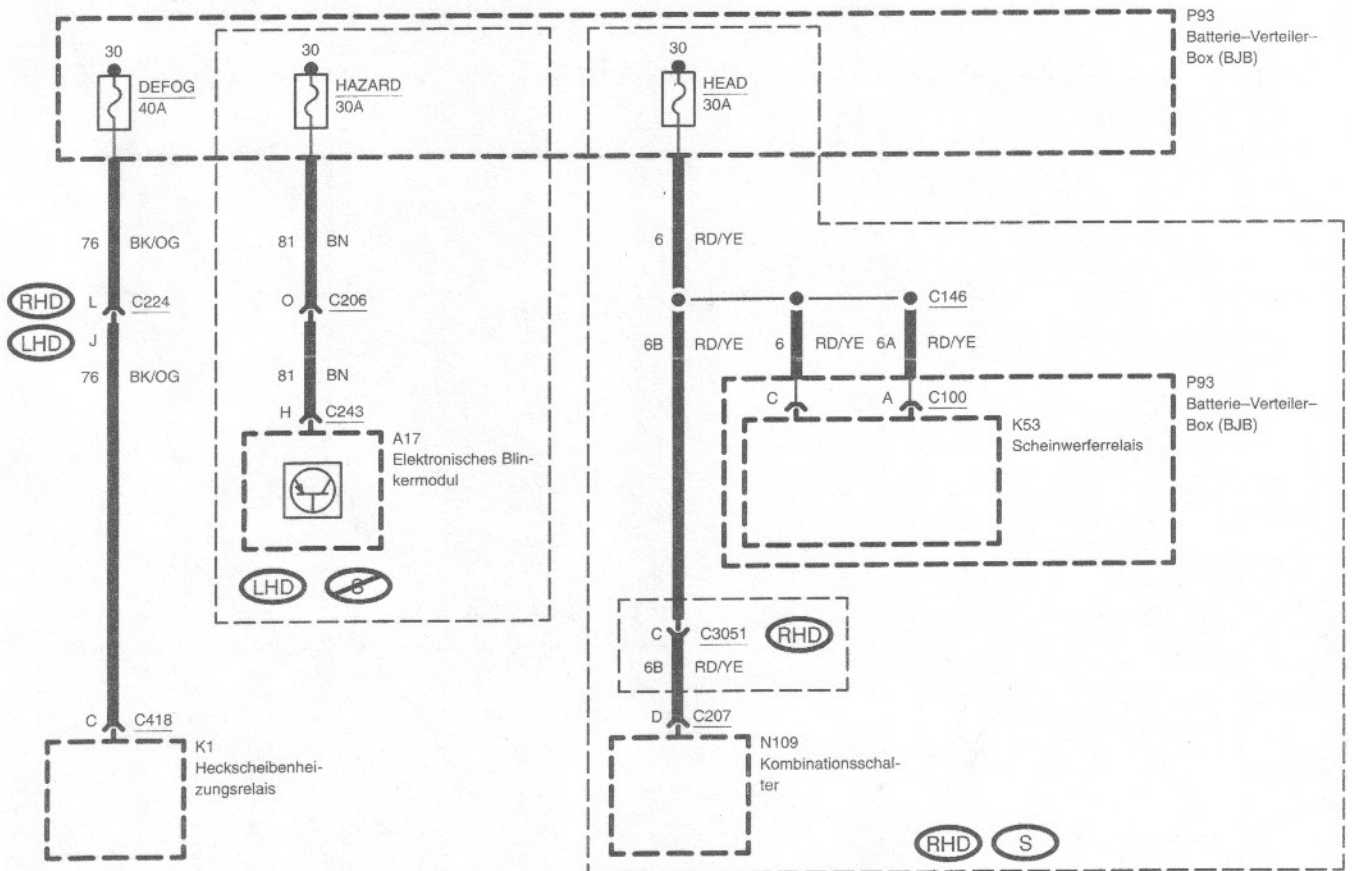

Batterie-Verteiler-Box (BJB)

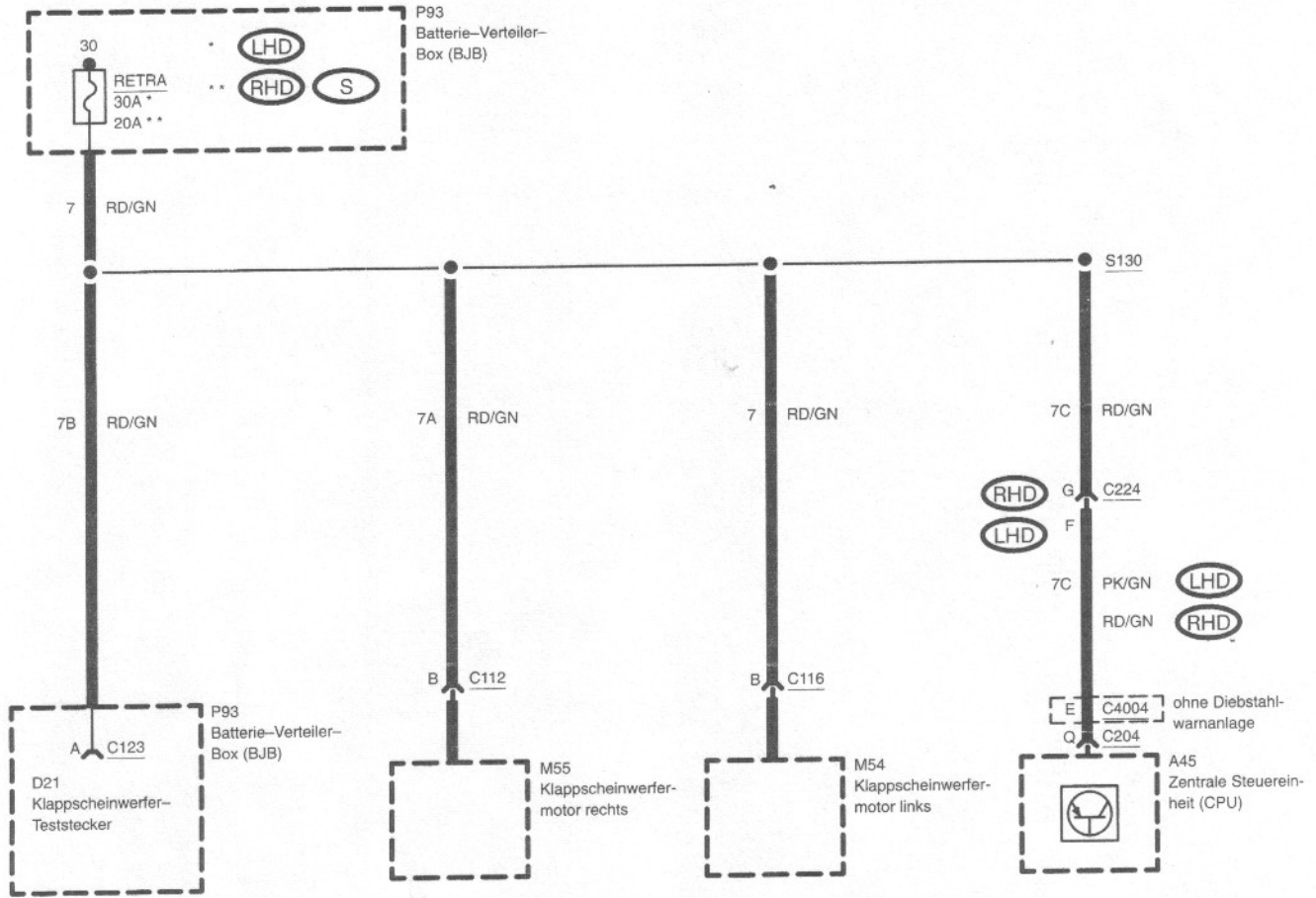

Batterie-Verteiler-Box (BJB)

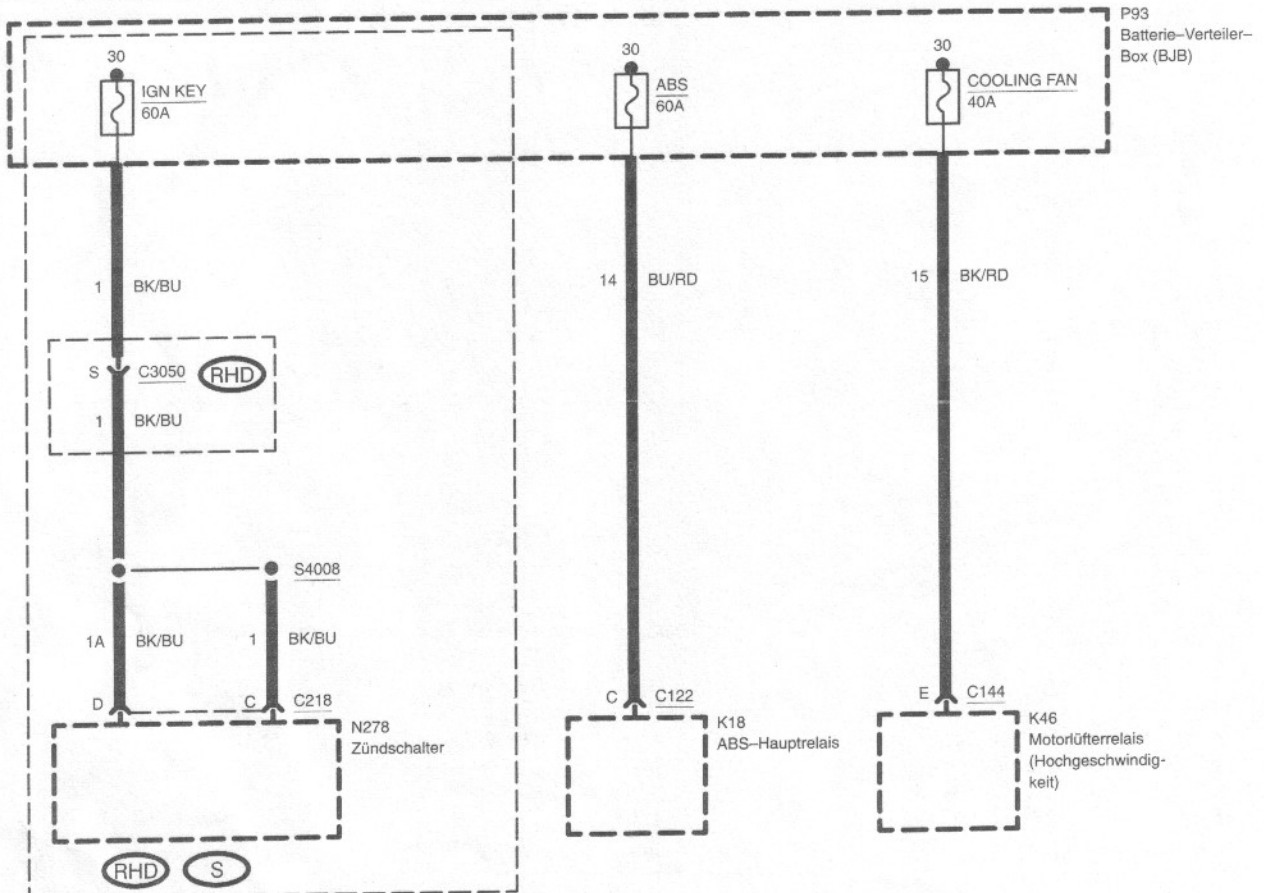

Batterie-Verteiler-Box (BJB)

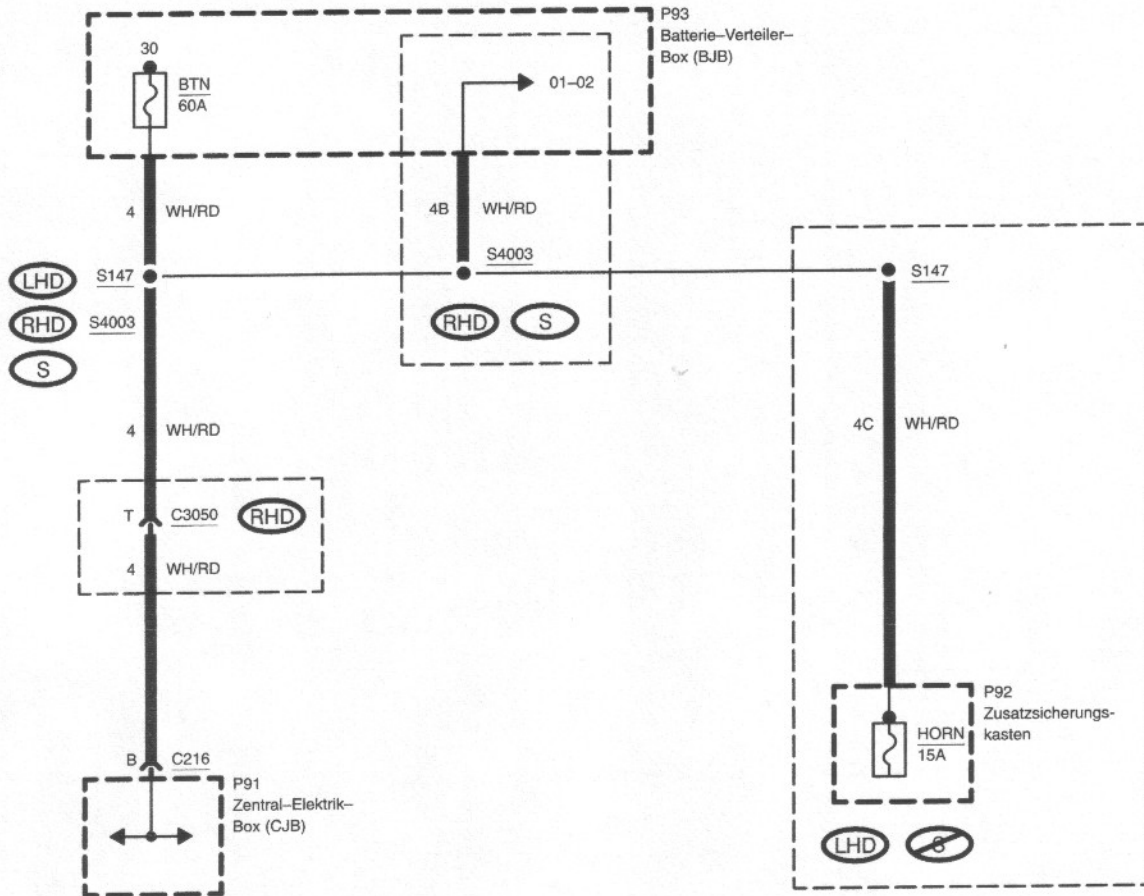

Batterie-Verteiler-Box (BJB)

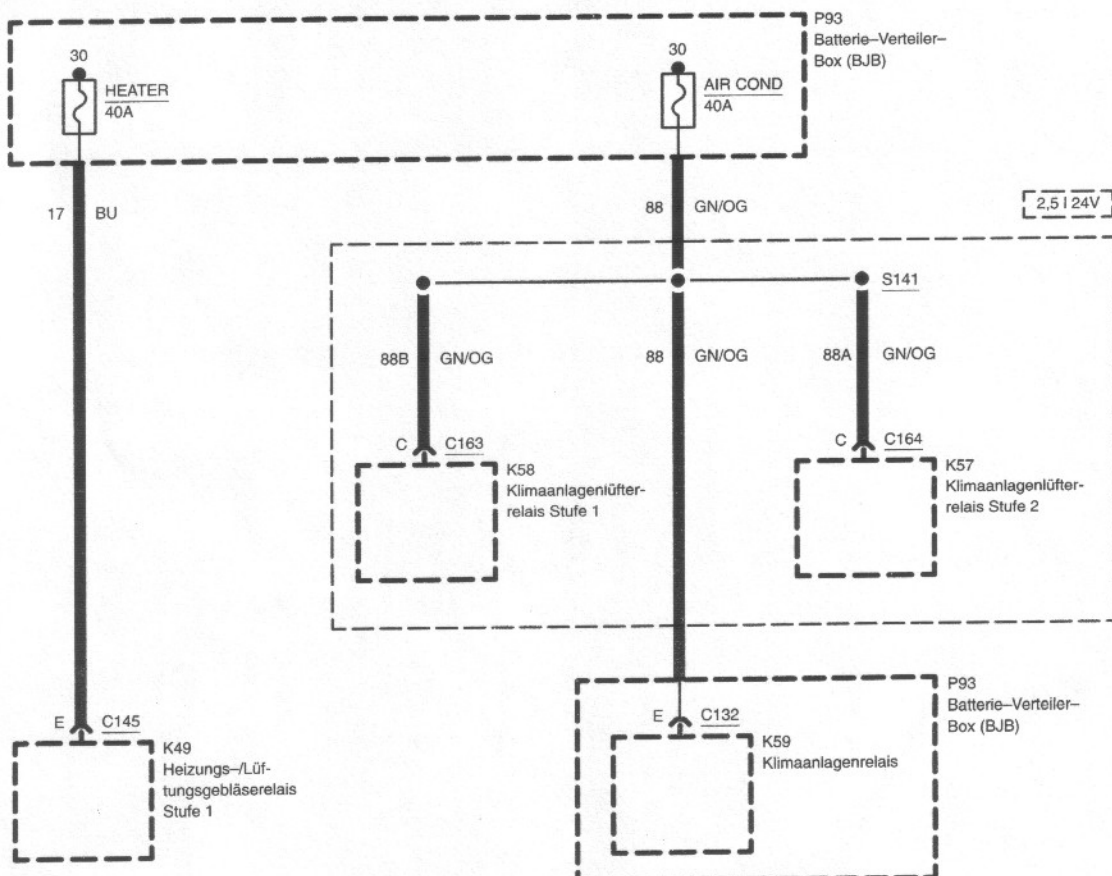

Sicherungsdetails

(RHD) , (S) Batterie-Verteiler-Box (BJB)

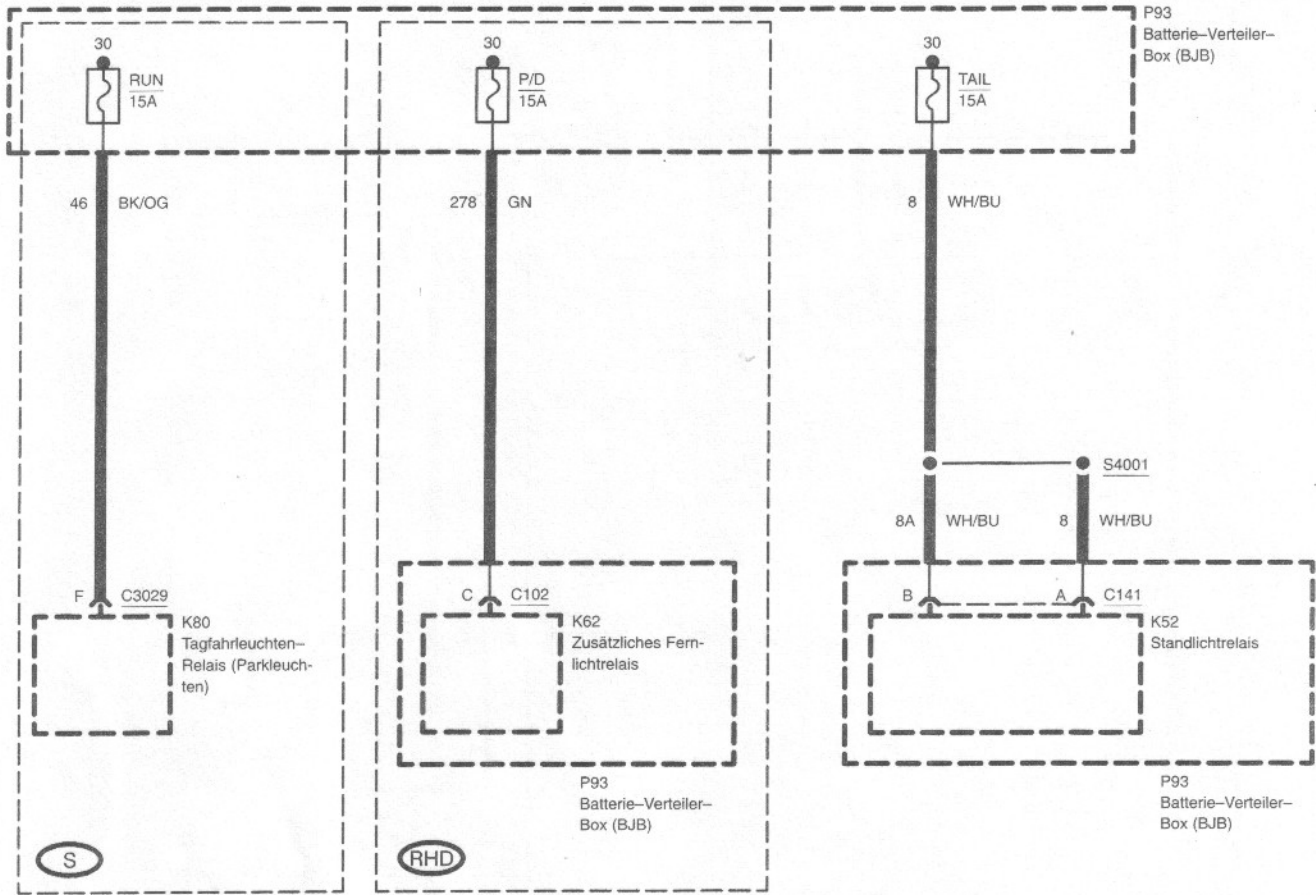

(RHD) Batterie-Verteiler-Box (BJB)

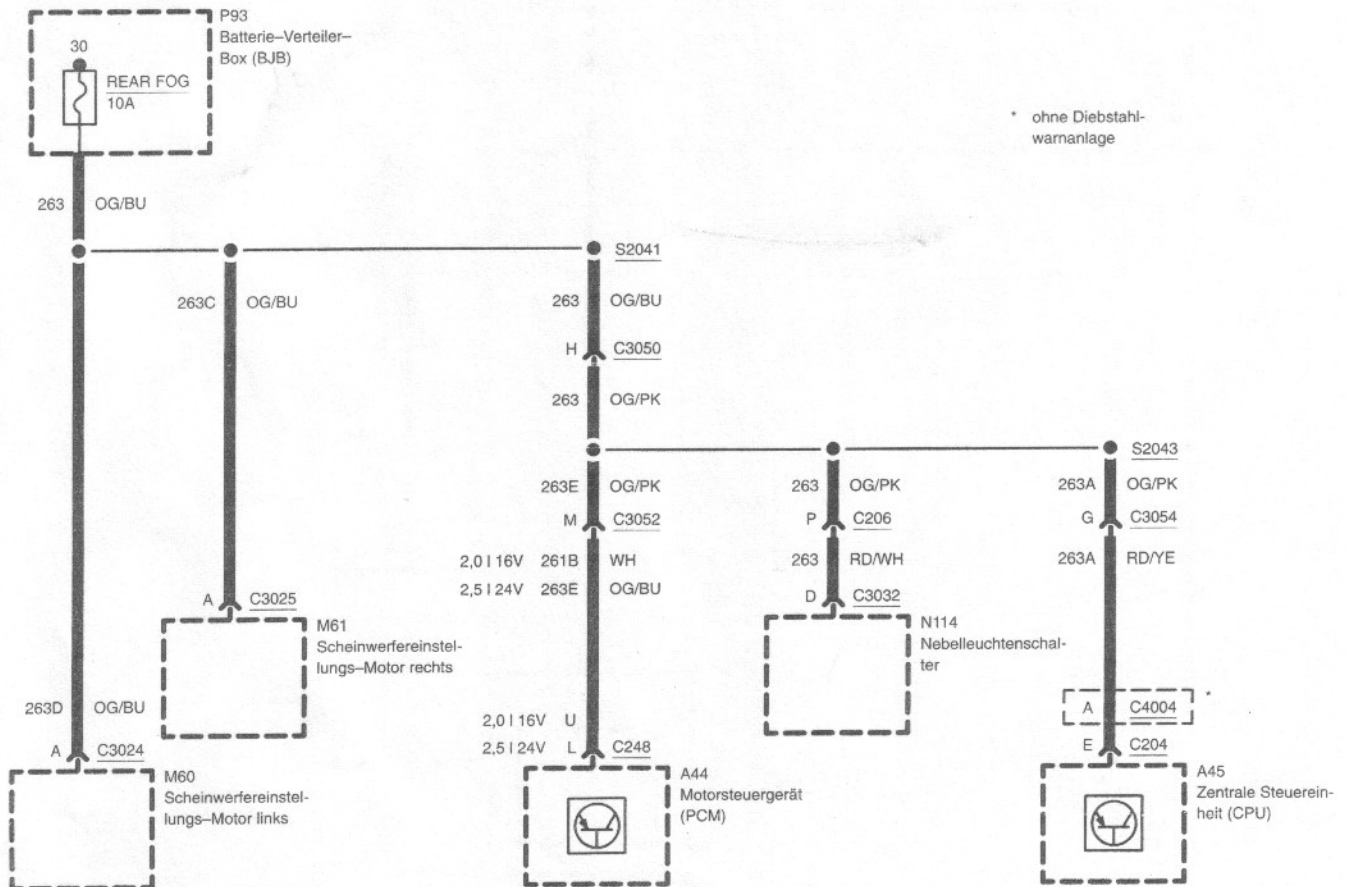

S Batterie-Verteiler-Box (BJB)

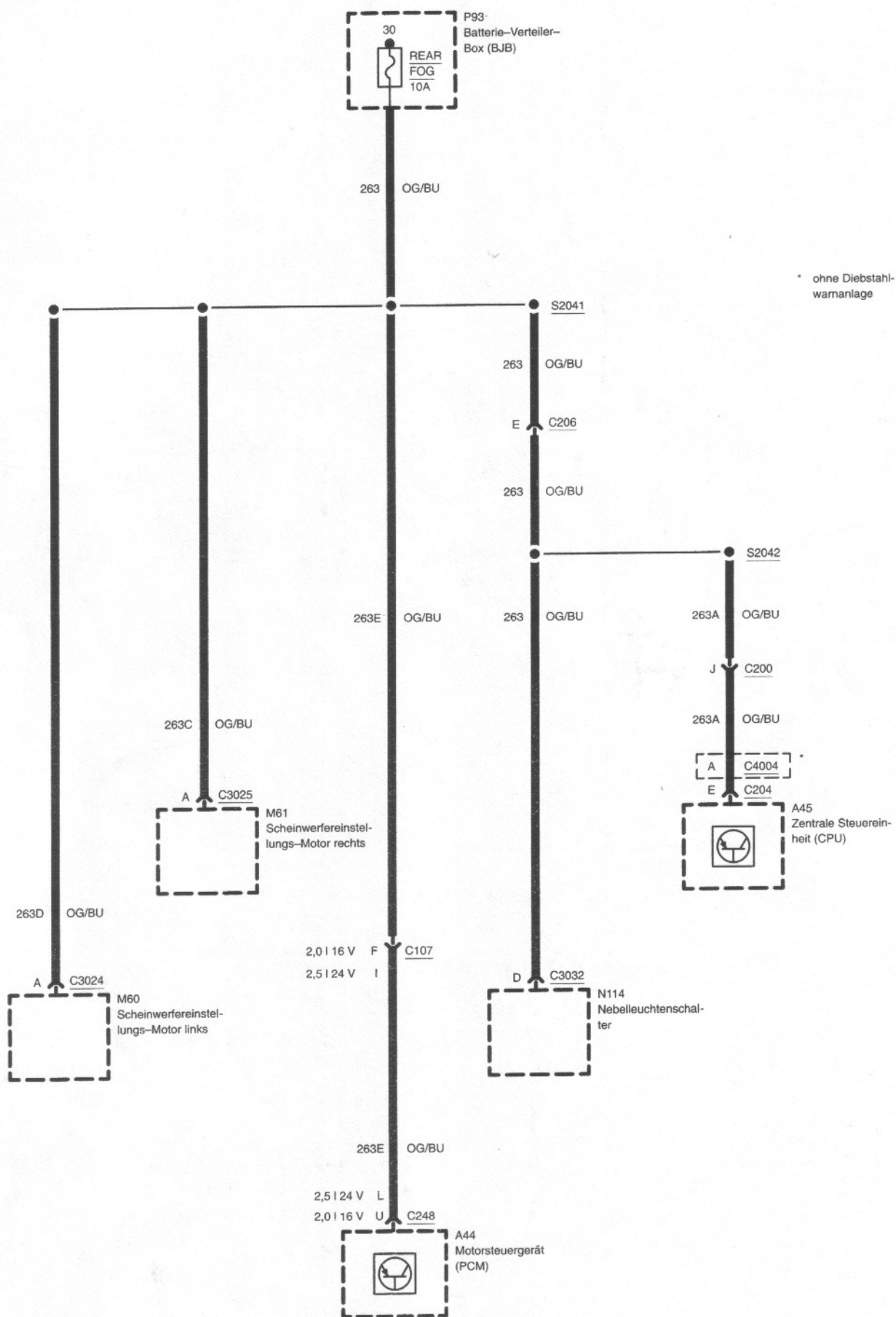

LHD Batterie-Verteiler-Box (BJB)

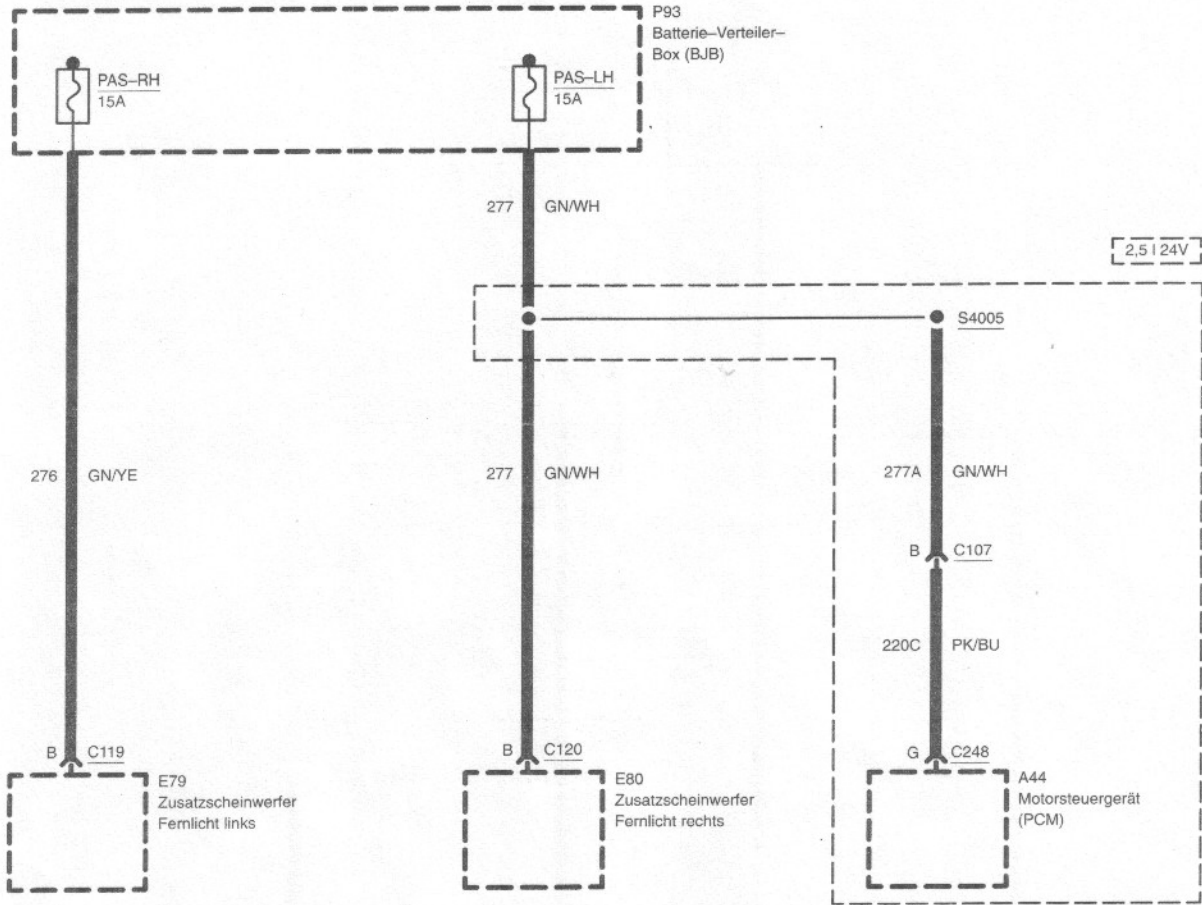

LHD Batterie-Verteiler-Box (BJB)

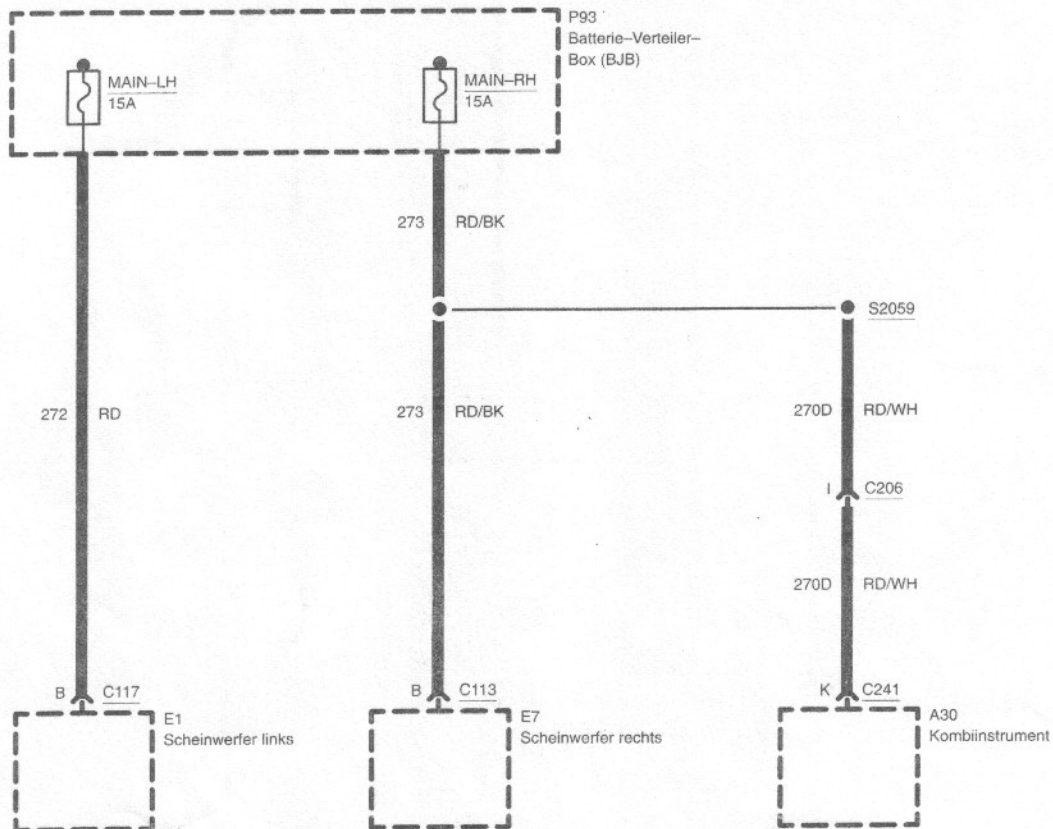

LHD Zusatzsicherungskasten

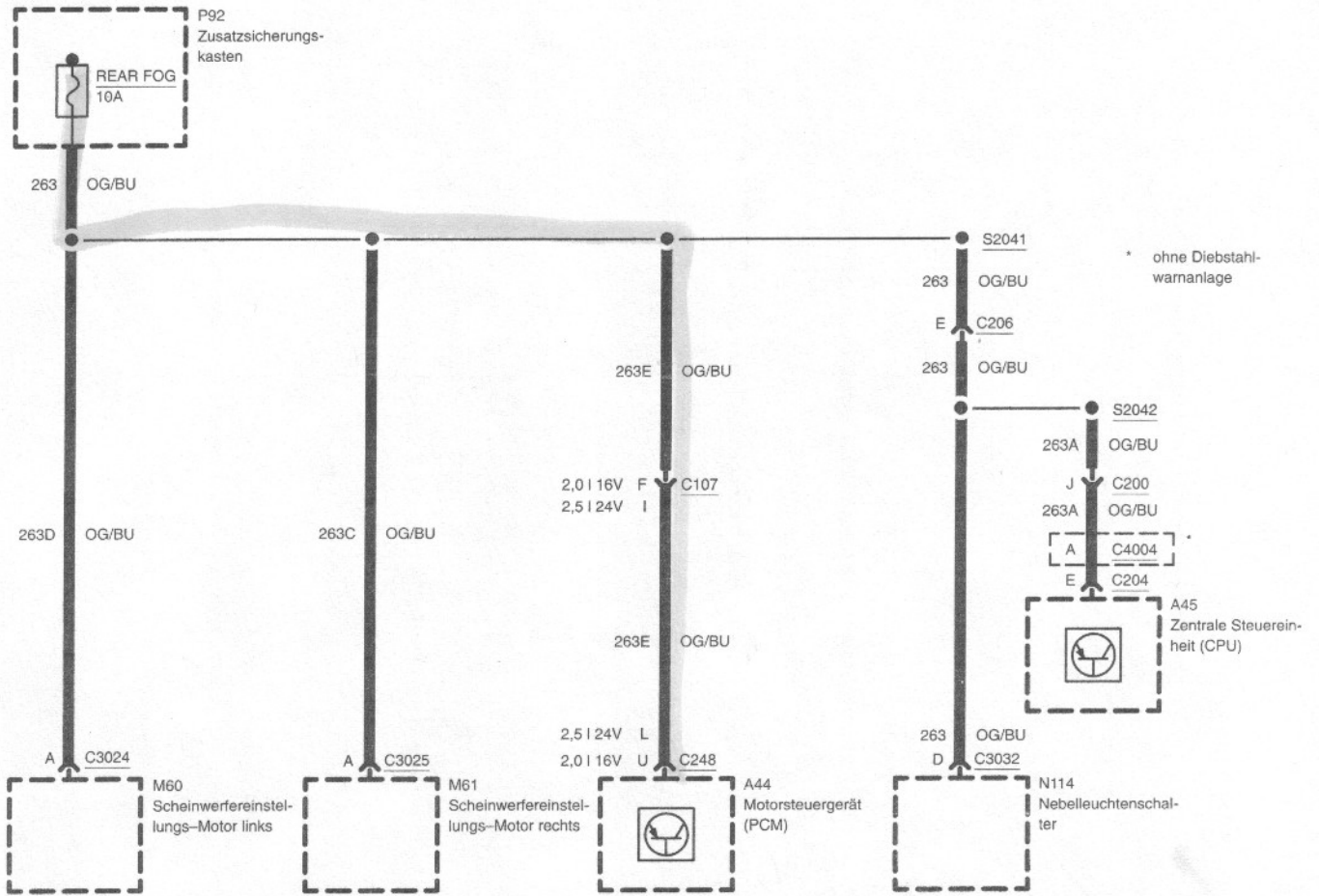

LHD Zusatzsicherungskasten

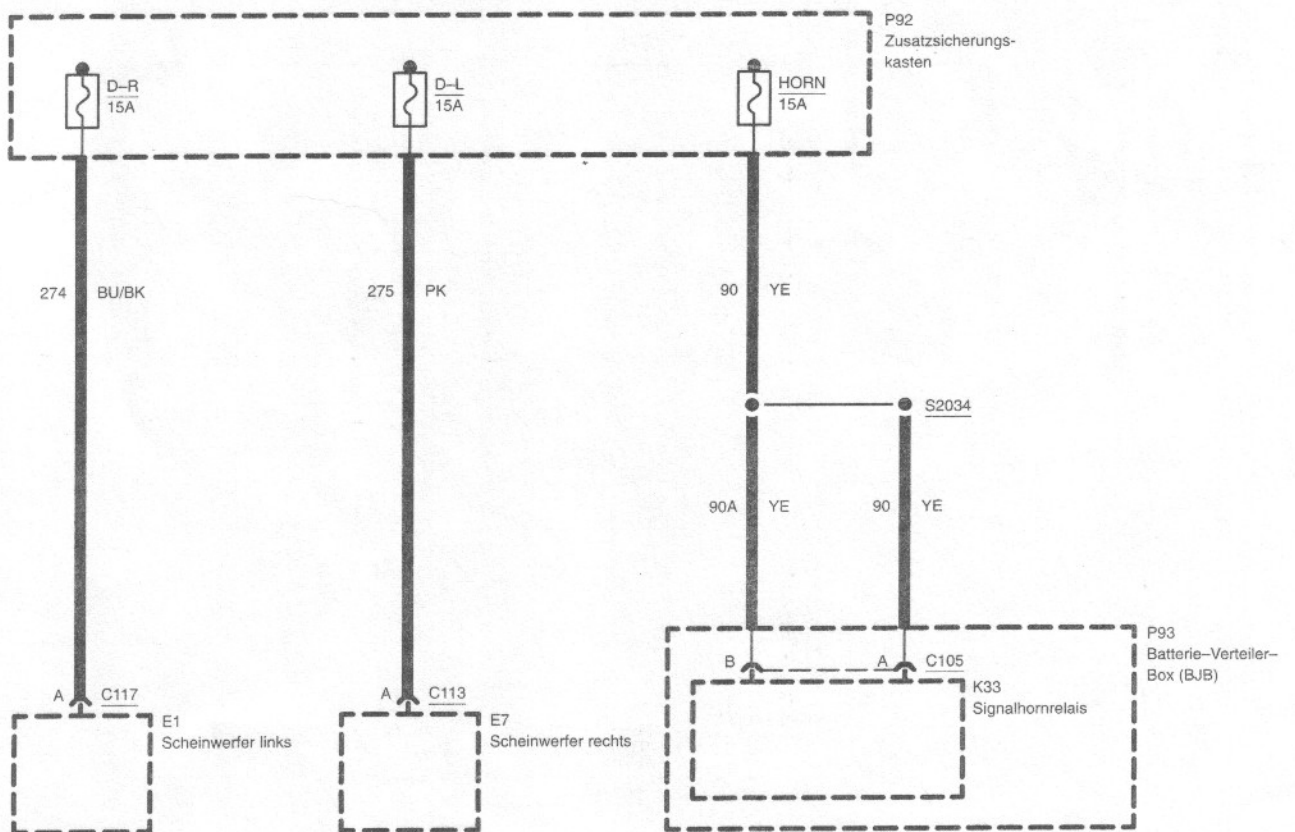

LHD Zusatzsicherungskasten

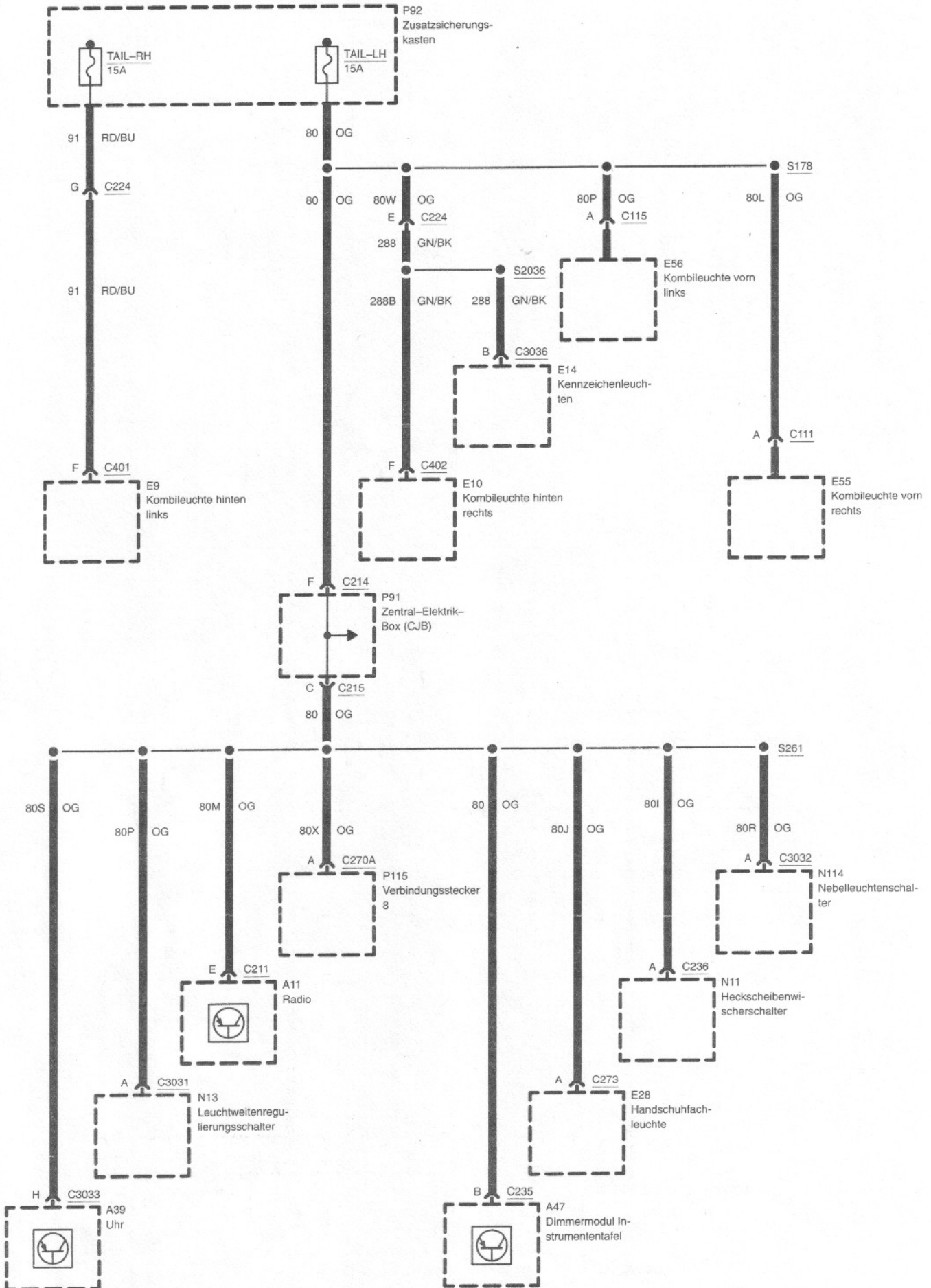

Zentral-Elektrik-Box (CJB)

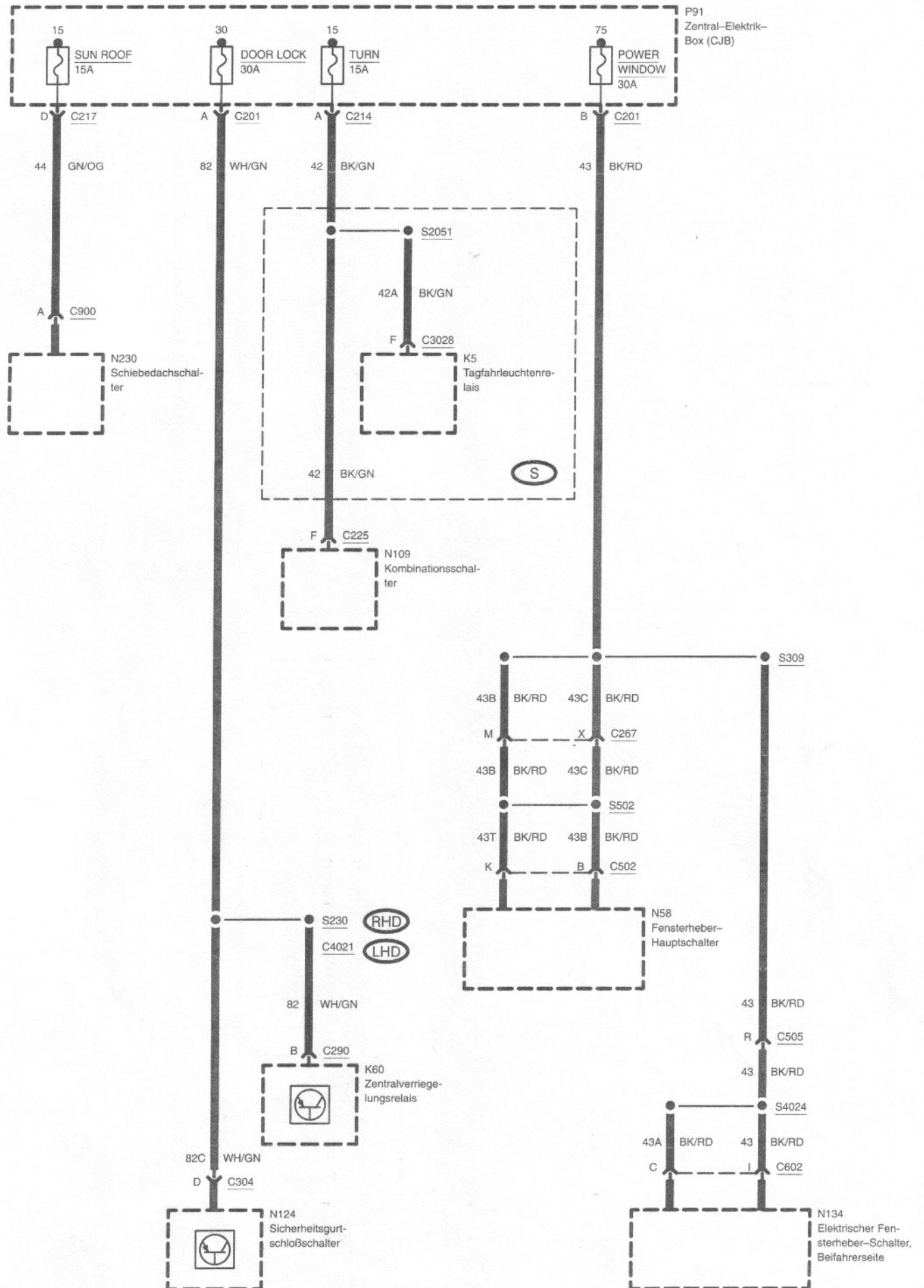

Sicherungsdetails

Zentral-Elektrik-Box (CJB)

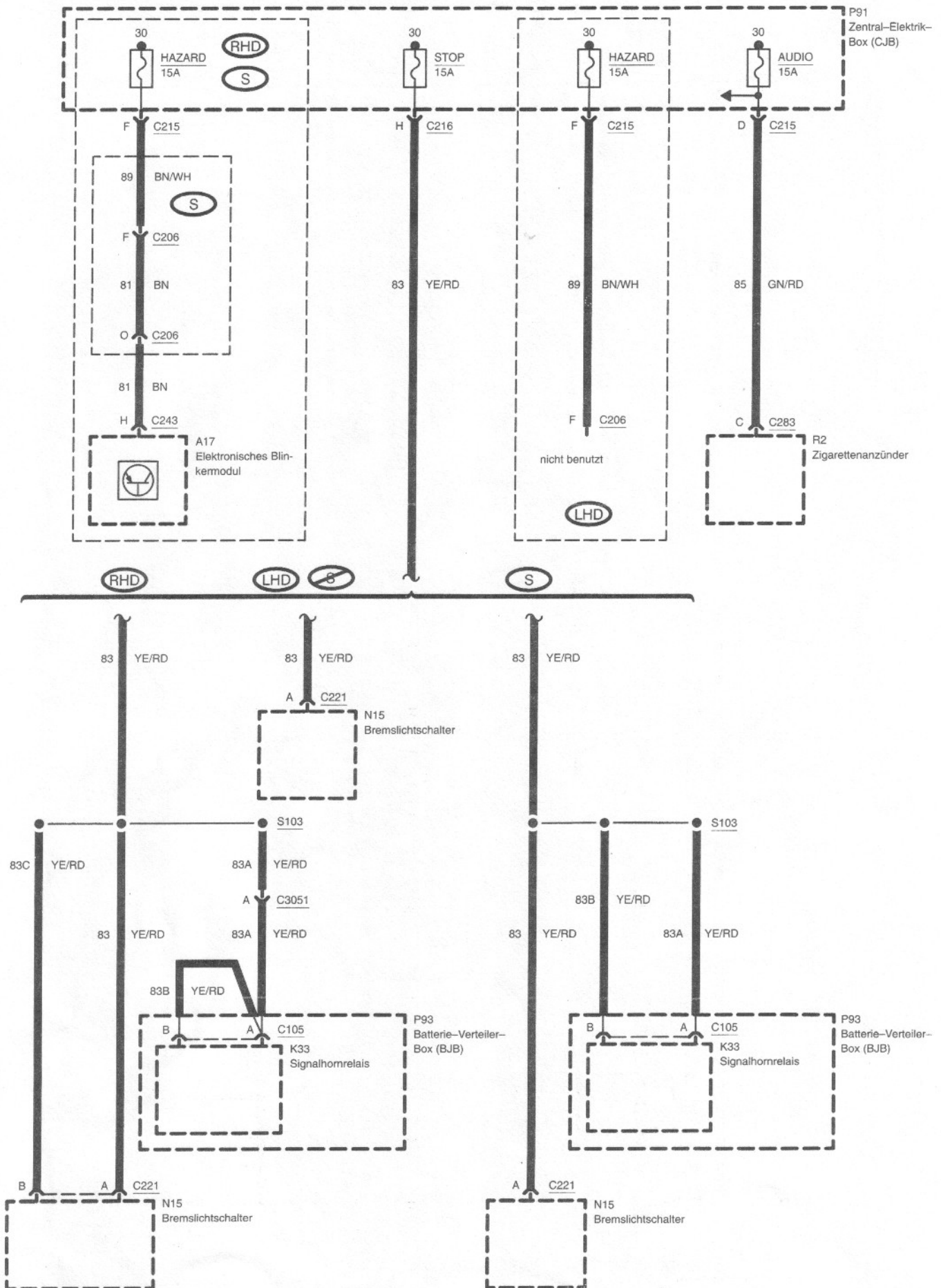

RHD Zentral-Elektrik-Box (CJB)

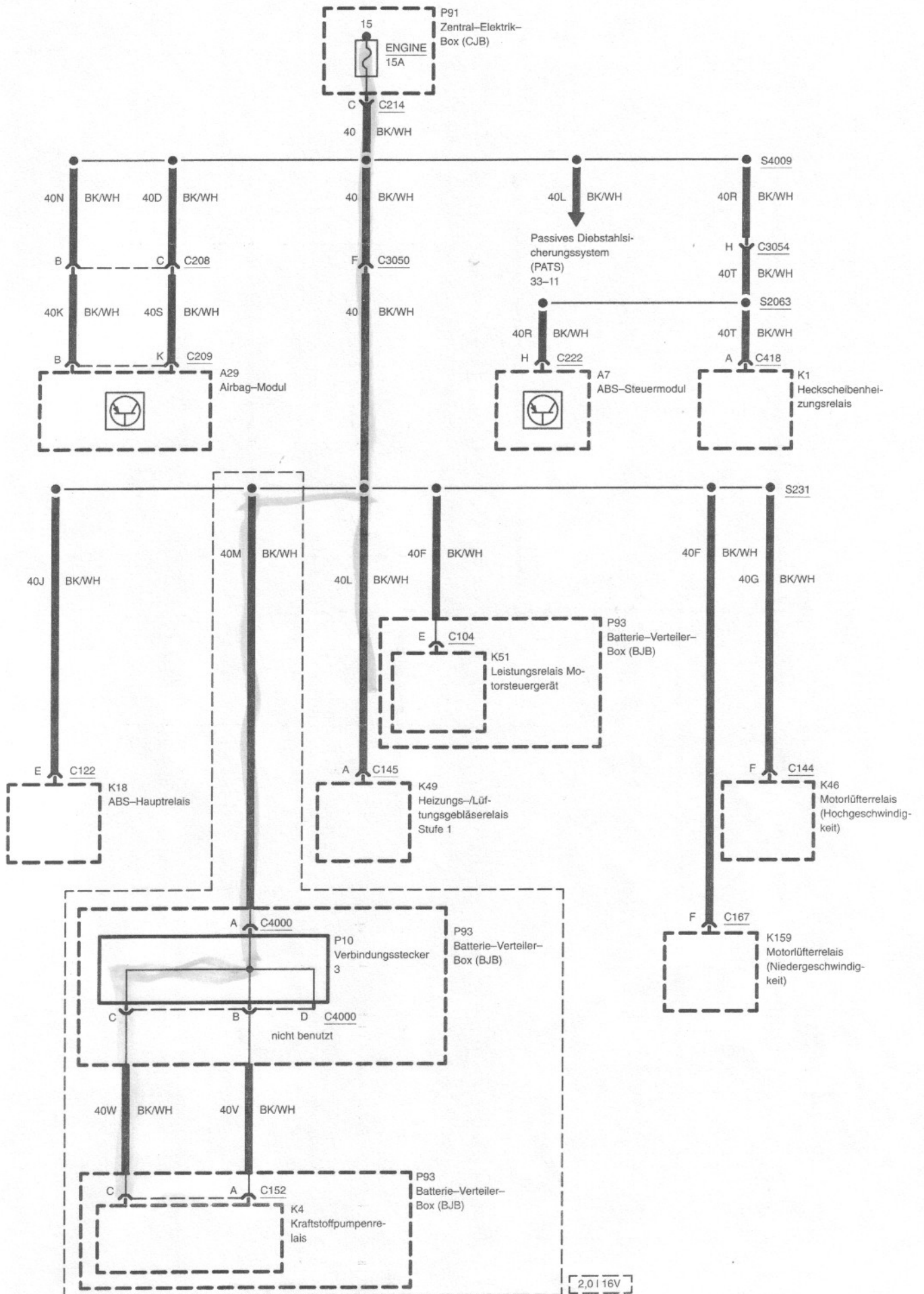

Sicherungsdetails

LHD Zentral-Elektrik-Box (CJB)

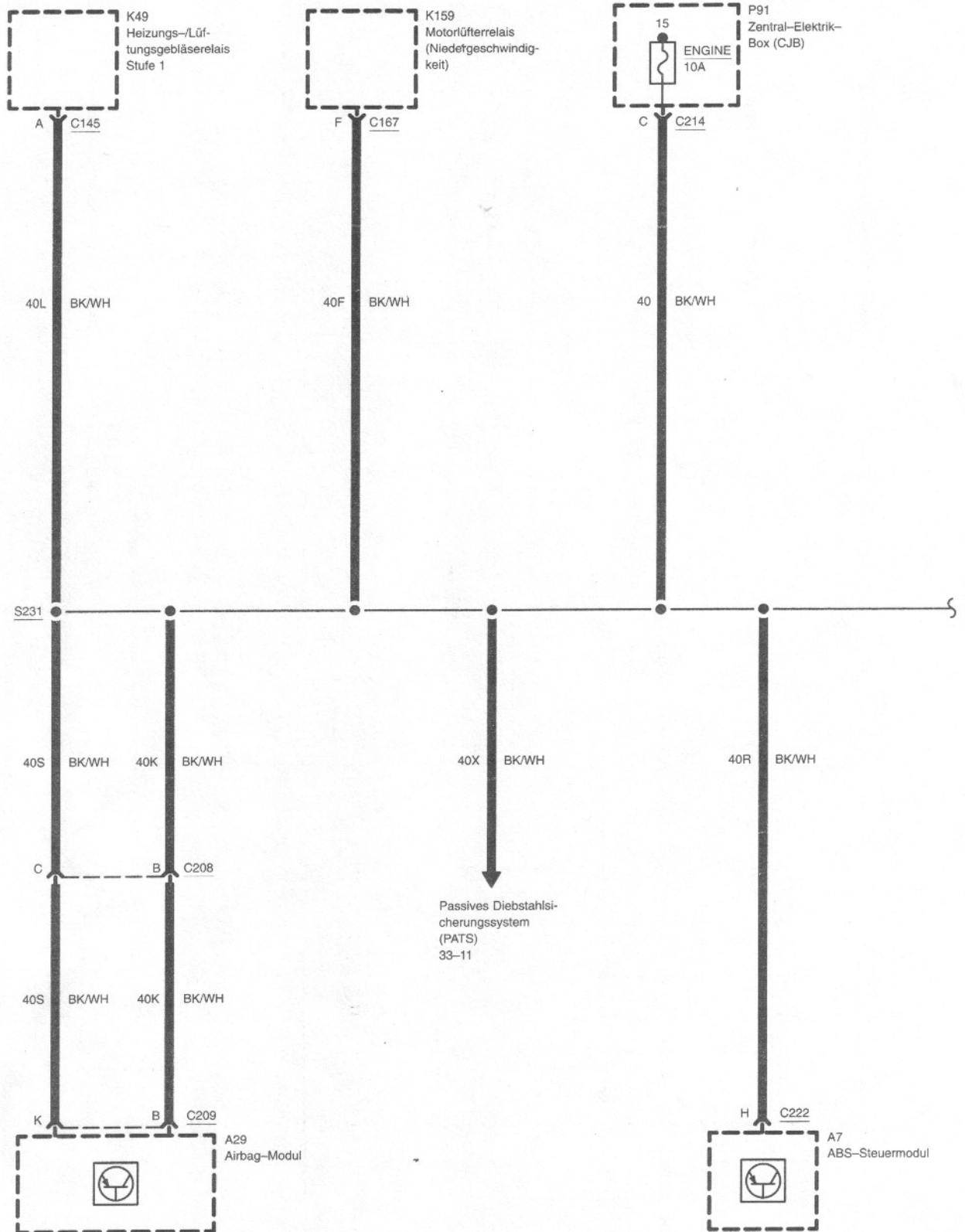

LHD Zentral-Elektrik-Box (CJB)

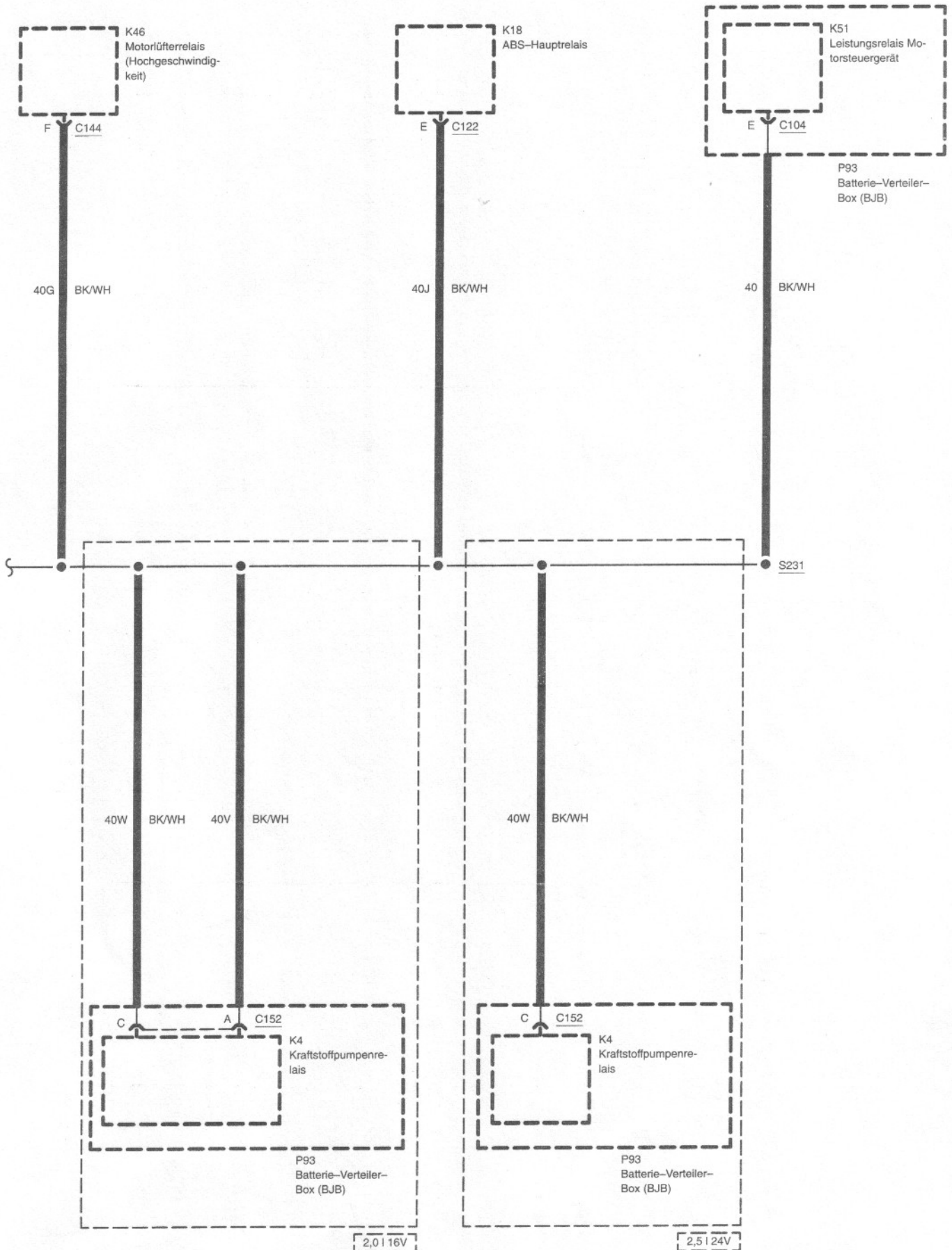

Sicherungsdetails

Zentral-Elektrik-Box (CJB)

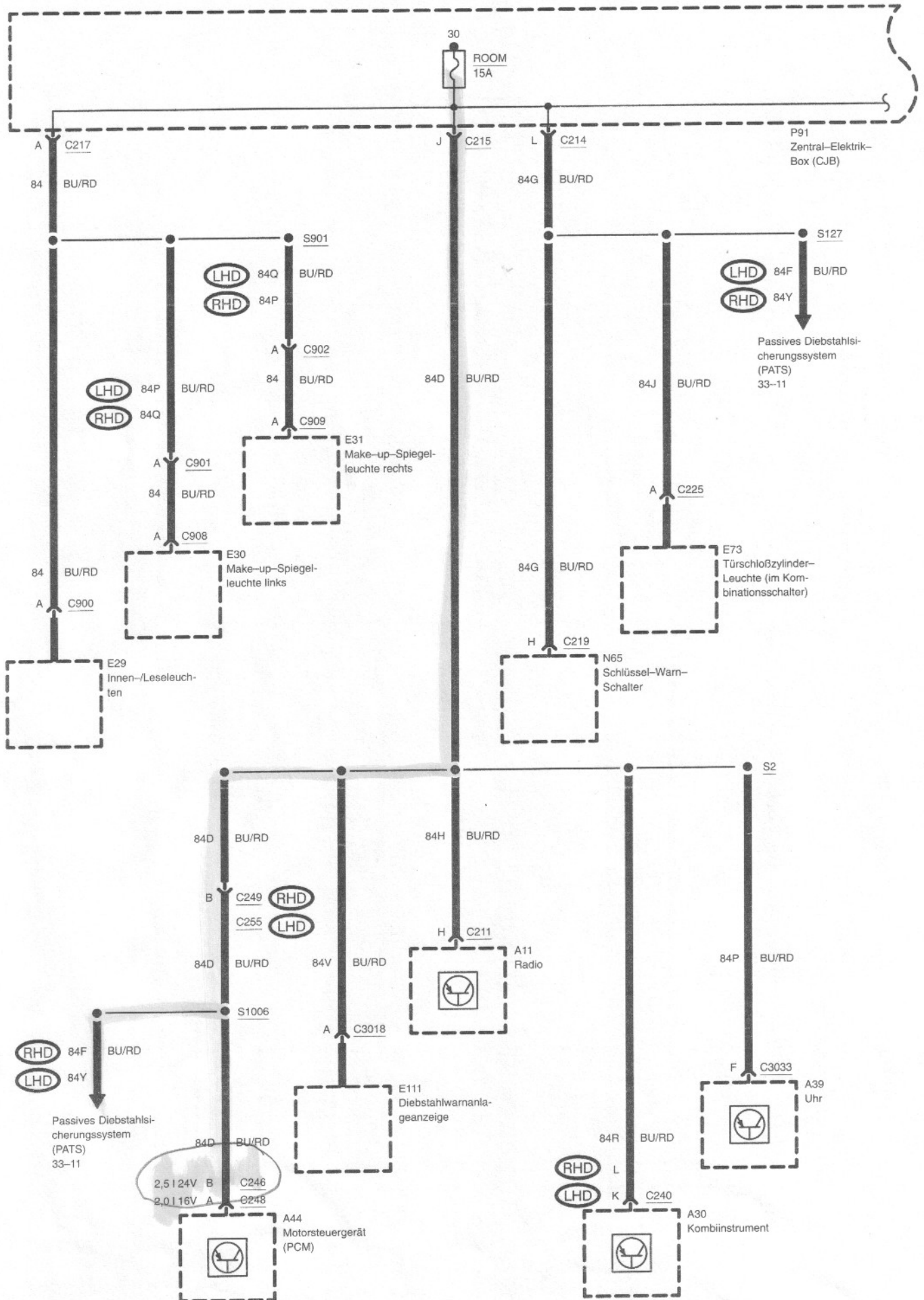

Zentral-Elektrik-Box (CJB)

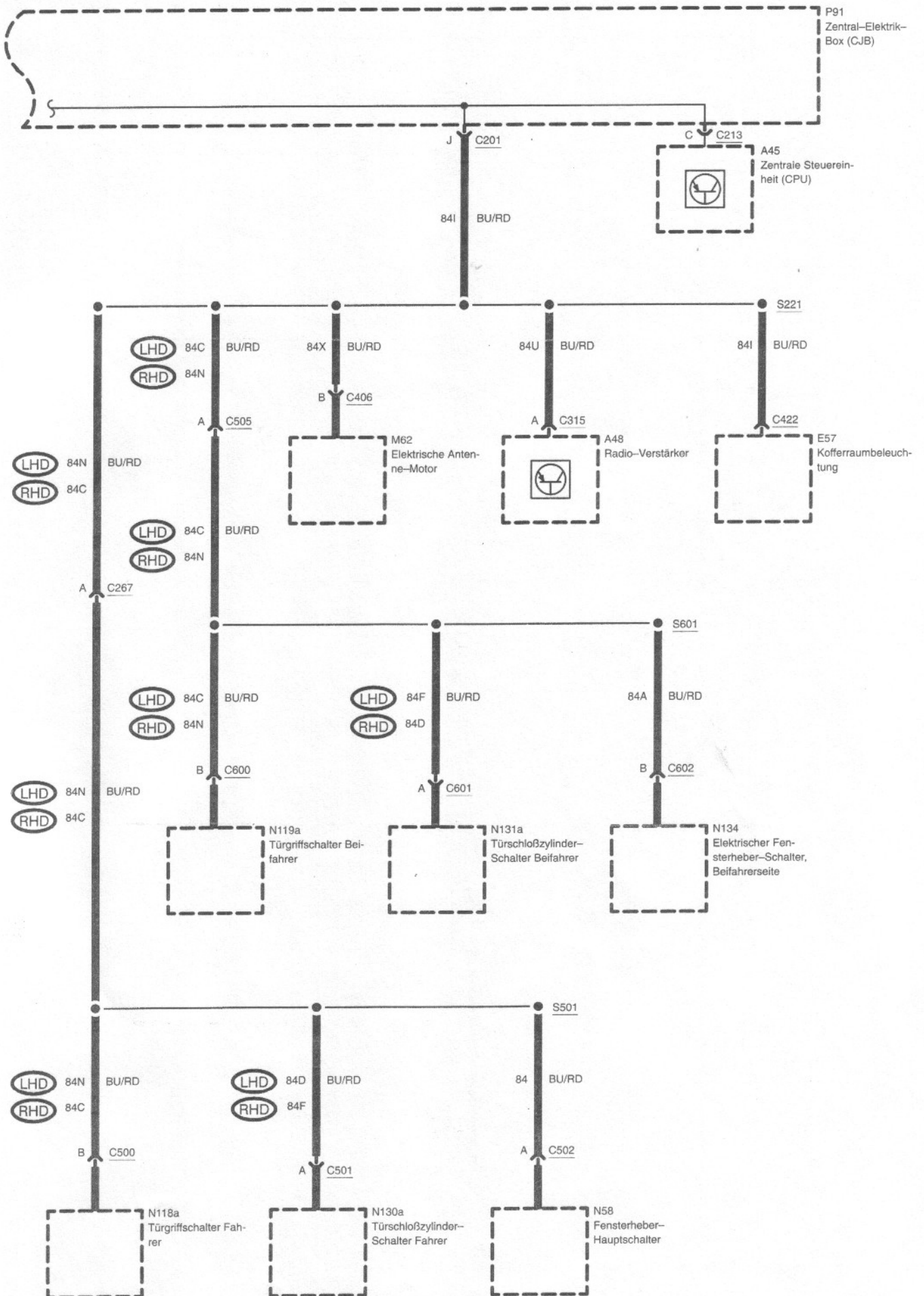

Sicherungsdetails

Zentral-Elektrik-Box (CJB)

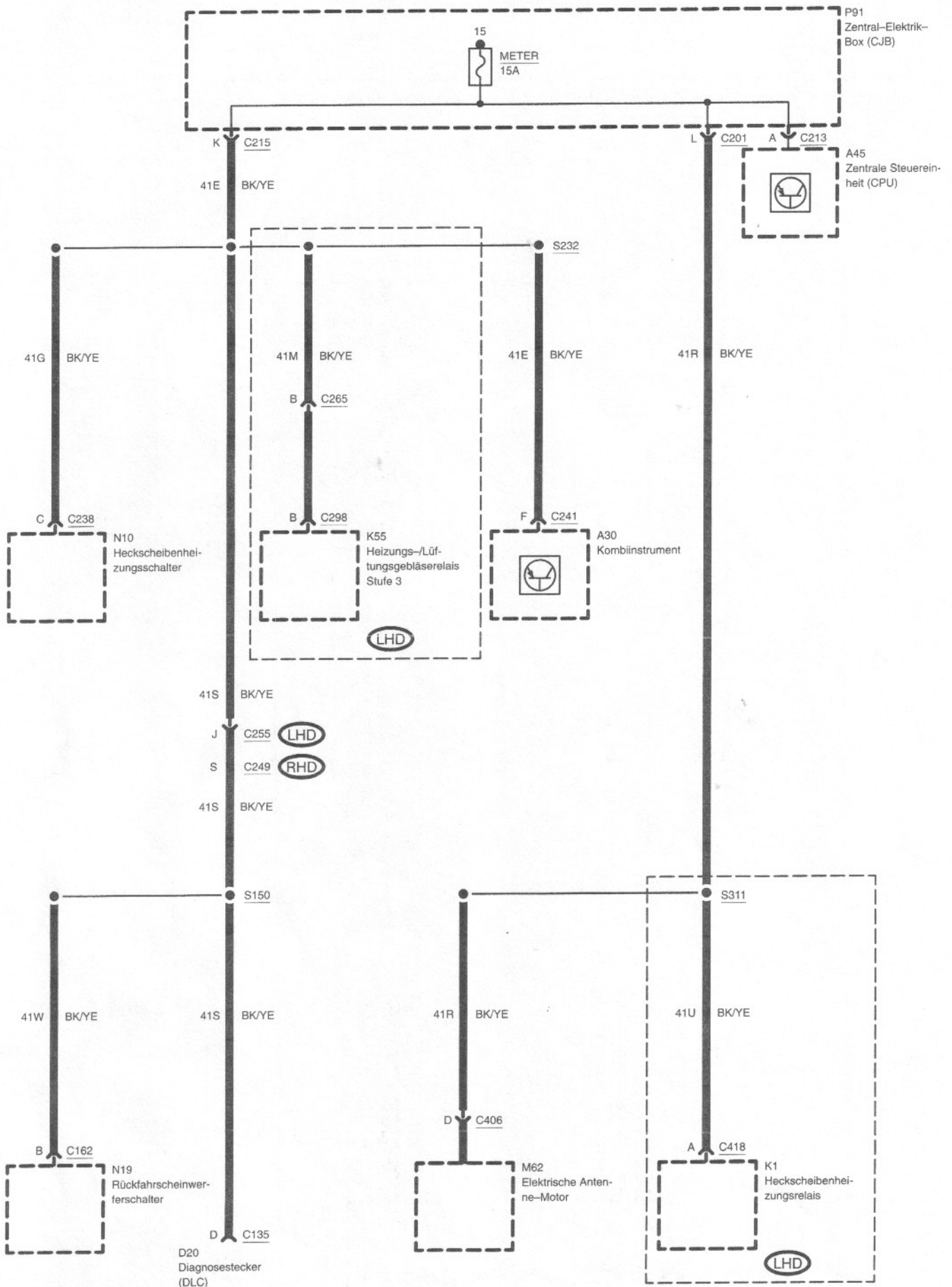

Zentral-Elektrik-Box (CJB)

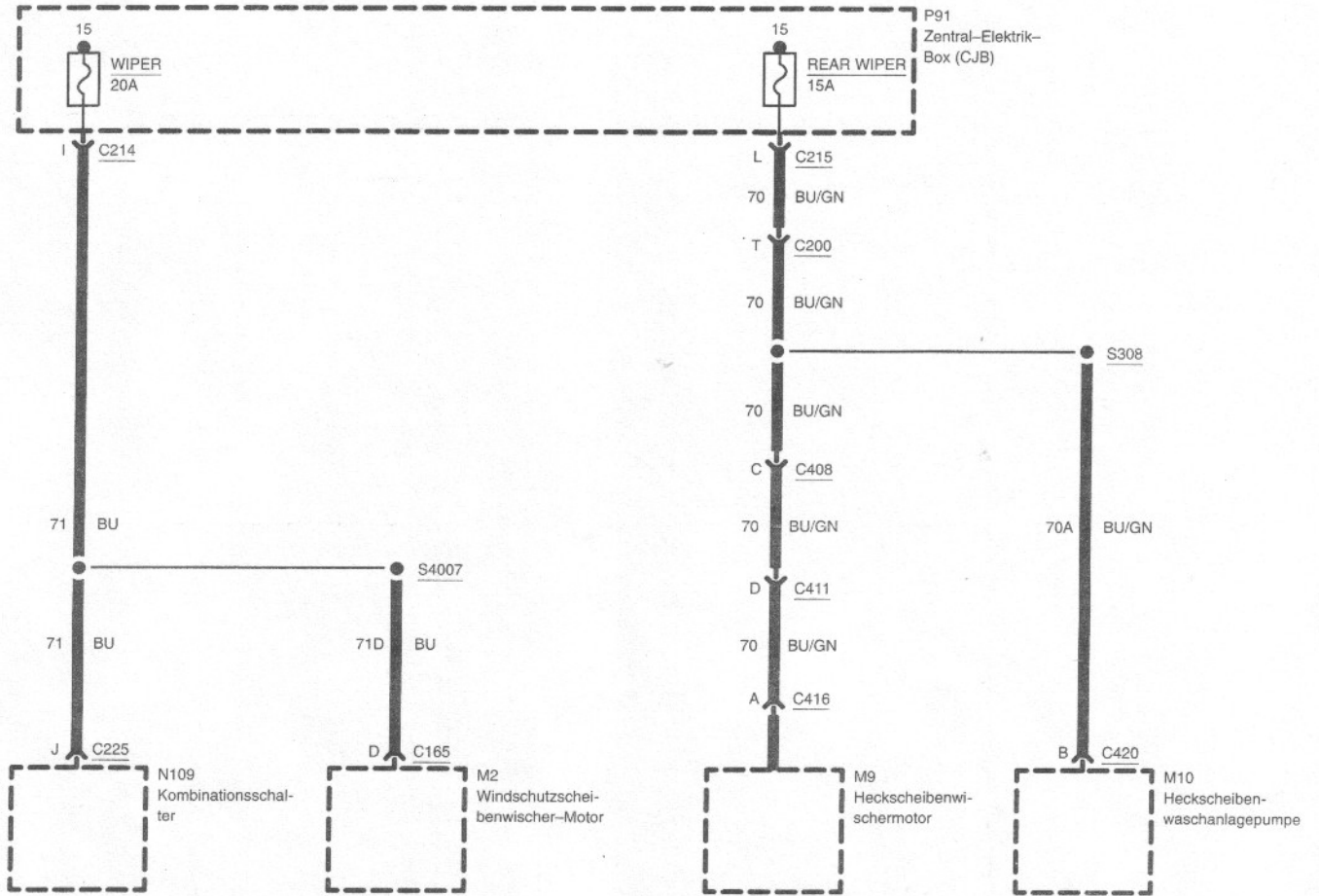

Zentral-Elektrik-Box (CJB)

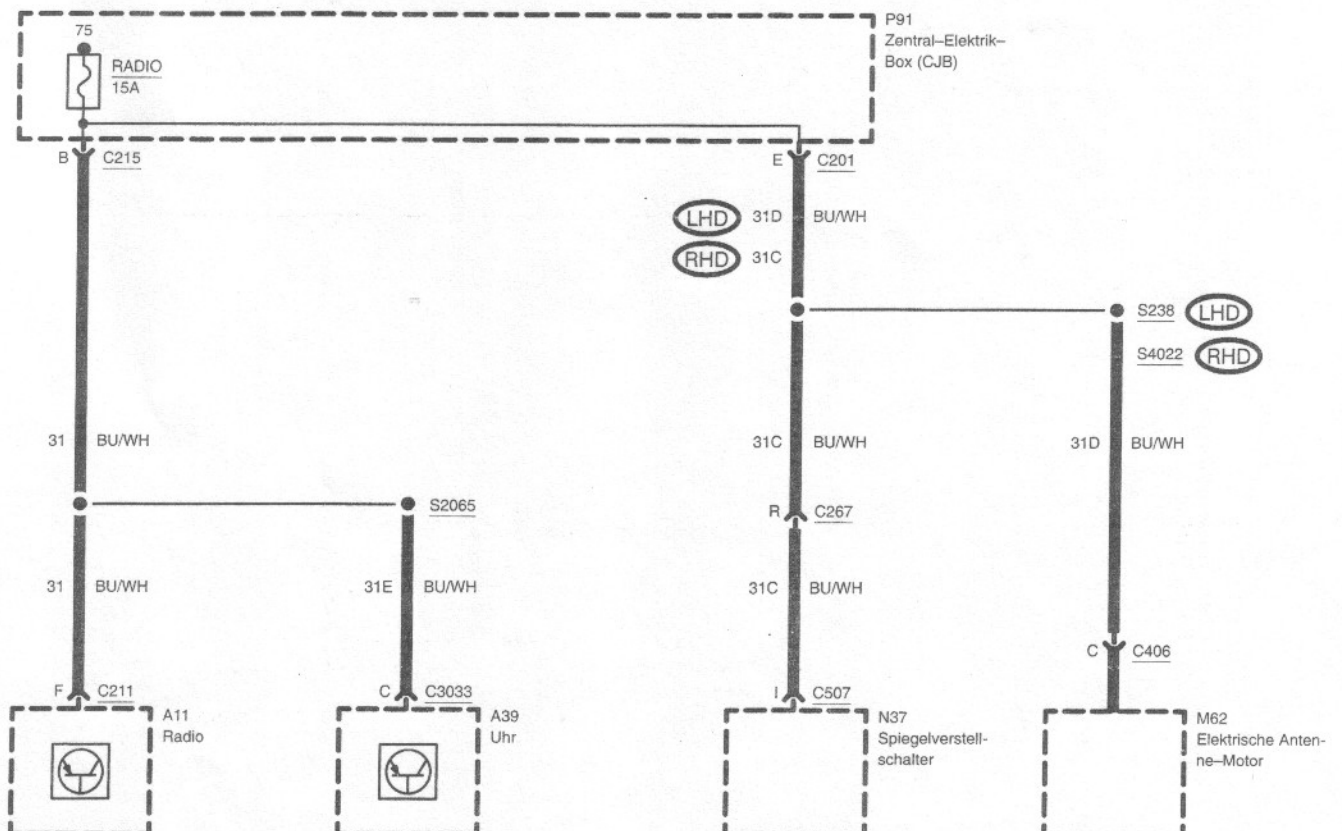

Sicherungsdetails

LHD Zentral-Elektrik-Box (CJB)

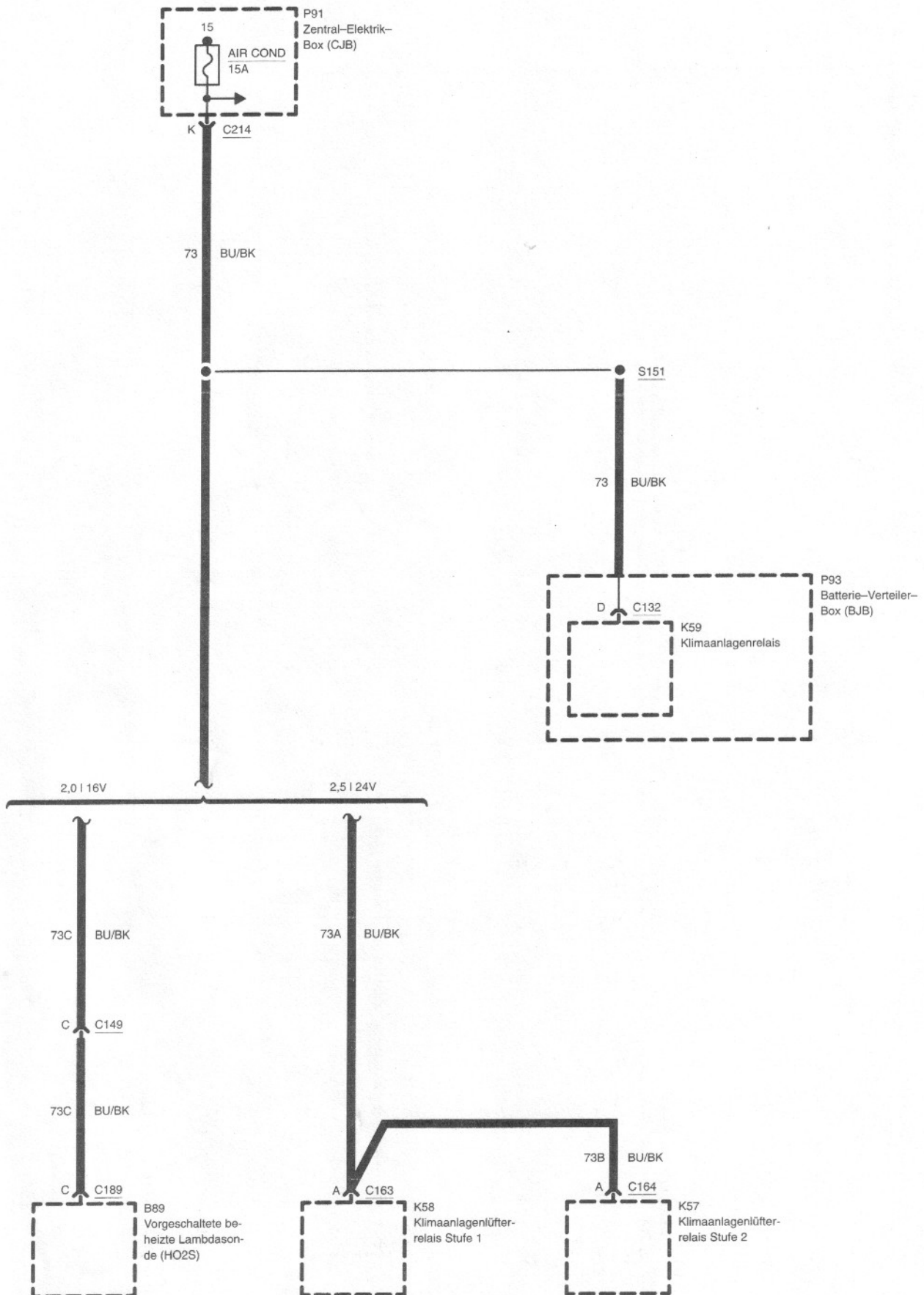

RHD Zentral-Elektrik-Box (CJB)

